

Eternal Words – The Least to the Greatest

The view of the structures, system, and universes as revealed are more fascinating than the pictures seen by the Hubble Telescope.

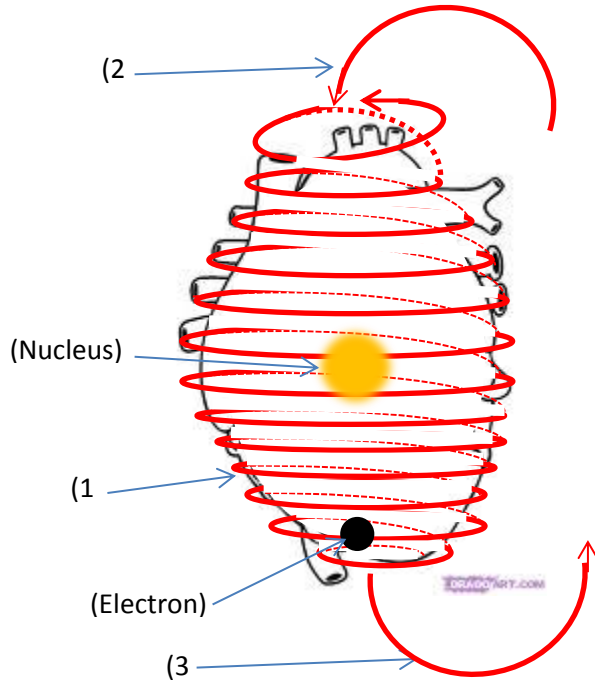

- i. Nucleus appears as a central sun.
- ii. The Electrons look like planets circling the sun

Truths Learned

1. Our world, especially humanity is in its infancy.
2. The atom has a universe perfected within itself.

The One Great Life will at one point unify our universes. At that point our consciousness will be unified with the conscious of the lower universes as well.

1. Path of Electron
 - A. The path is a complex spiral path.
 - B. The path creates lines of force. The path is irregular.
 - C. The path of one electron does not infringe on the path of another electron.
 - D. The shape of the path is like a human heart.
 - E. The atom had the appearance of beating or pulsating.
2. A vortex at the top of the formation which is taking an inflow of force.
3. Releasing the force at the bottom.
4. This is a living thing
5. The atom could communicate.
 - A. Communicated by fast impressions
 - B. The atom is asleep to our world & awakening on others.
 - C. The atom evolves.
 - D. Completed its evolution long ago.
 - E. Joined consciousness with other atoms.
 - i. To reach out & identify with others of their higher form.
 - ii. Different dimension of time.
 - F. Joins consciousness with others continually.
 - G. Can feel & express emotion.
 - H. Has capacity to see & perceive through the eye of the Ancient of Days.

Electron of Carbon Atom

Phase in & out of “pure spirit”

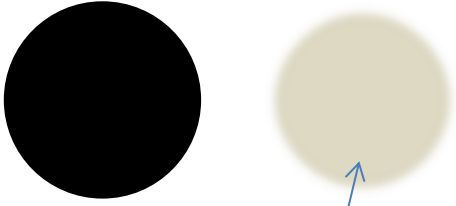

Fabric like substance, similar to water filling hole.

1. The electron has reached relative perfection & completed their evolution.
2. It has reached a balance between spirit & matter.
3. Neither spirit nor matter.
4. It is living in both worlds simultaneously.
5. When the electron went out of existence into the world of pure spirit, it left a type of fabric, like water filling a hole when it returns, it is like pushing the waters of space back.
6. The electron is a particle half the time and a wave the other half.
7. From the electron’s perspective, the nucleus looks as far away as the planet Venus does to us in the night sky.

Nucleus of Carbon Atom

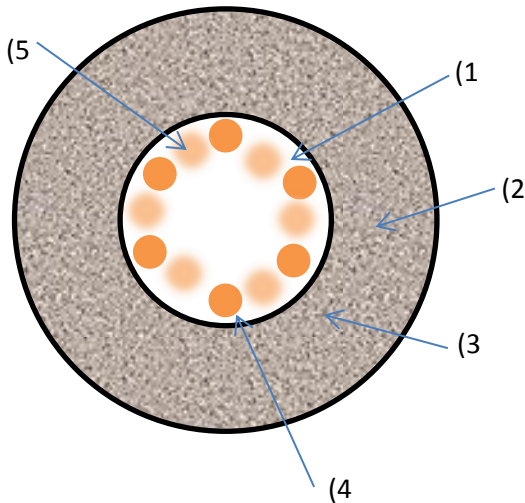

Truths Learned

1. This universe had a beginning & will have an end, but in the end it will leave a seed that will give birth to a new and expanded universe.
2. In the new universe, several of the archetypal atoms will become complete atoms, about a handful. The number will be greater as each universe materializes.

1. Nucleus
 2. Appears as cloud of dust particles.
 3. Particles are infinitesimally small called archetypal atoms which are waiting to be born. There are approximately 14 billion in each atom.
 - A. A small number will evolve into greater particles in this universe.
 - B. It will take a span of the lives of many universes before all are born as atoms.
4. Protons
 - A. Are similar to electrons, passing in & out of existence.
 - B. Phasing is directly opposite of the phasing of electrons.
 - C. Between proton & electrons, there is always one in existence.
5. Neutron
 - A. Neutron does not oscillate
 - B. Outer shell of neutron is composed of 2 layers.
 - C. Both layers phase in & out, but at separate harmonious times, always leaving self in this plane.

Proton of Carbon Atom

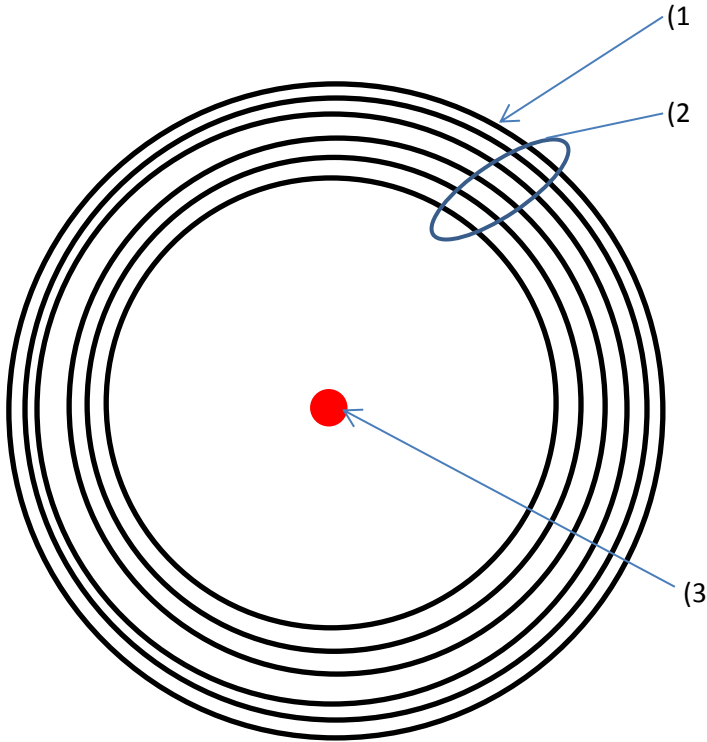

Proton of Carbon Atom

1. Surface is not solid. It is a magnetic force that interplays with the fabric of space.
2. There are 6 protective layers to the center of the proton
3. Center of the proton
 - A. Very small compared to the overall size of the proton

Center of Proton

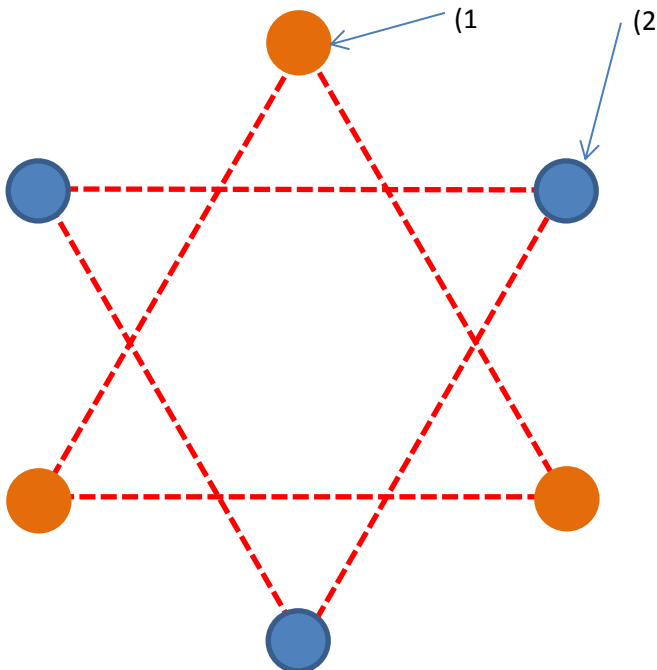

1. Three Quarks
2. Three Leptons
 - A. Appearance is as the Grand Star of David.
 - B. The Quarks & Leptons pass in & out of existence.
 - i. One Quark is always in existence
 - ii. Same with Leptons
 - iii. The Quarks & Leptons move in & out of existence synchronously as if it were a choreographed dance
 - iv. The number 6 is manifest twice
 - v. This is the universe of 6

Truths Learned

1. The universe we live in is based on the number “7”.
 - A. Beginning with the 7 electron shells of the atom stretching to the universe of Galaxies.
 - B. Atoms can naturally achieve a maximum of 7 electron layers, which the foundation of “7” goes throughout all greater creations.
 - i. Seven colors
 - ii. Seven basic notes
 - iii. Seven rays, etc.
 - C. Before the greater universe based on the number 7 existed, the mind of God manifested in this lesser universe founded on the number “6”.
2. The creation of micro universes happened in a very short period compared to our time period. This very short time period is what scientist refer to as the “Big Bang Theory”.
 - A. Many eons passed in the lives of those that existed in the creations covered by the number “6”.
3. Where there is form, there is life in that form
4. It is not yet revealed how life is manifest in the lower worlds.
5. Time is no longer consciously registered by the atom or the lives within it.
6. At the first instant of creation, time was consciously registered and the tiny lives spent what was an eternity to them in achieving perfection in their sphere.
7. When perfection was achieved, the lives within merged into the higher form and now seek to share consciousness within our world.
8. All the lives in the atomic world are currently asleep. Their work accomplished, now functioning on auto-pilot.
9. Their consciousness has moved upwards, seeking expansion. In a future universe they will awaken again to this plane of existence and build again better than before.
10. Because atoms are asleep in their sphere of existence, billions of years of time would technically pass within. The atom, the lives there do not consciously live through all that time.
11. The smaller lives seeking consciousness in our greater universe are governed by our reckoning of time.
12. The creation & perfection of their lives, they passed through billions of years, but in our time it would be less than a second of our time, from our perspective. This is the ”Big Bang”.
13. The universe within the quark is on a higher rate of vibration than ours.

The Quark

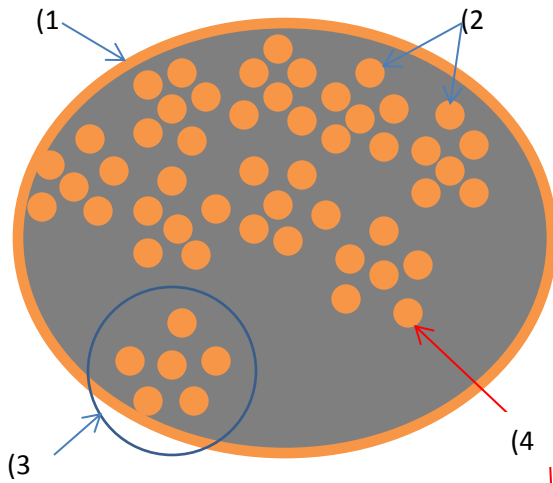

1. Initially the quark appeared as a large, somewhat elliptical ball of fire.
2. As you get closer, no longer does it have the appearance of fire, but like dots in the night sky.
3. Dots are loosely groups in formations of "6".
4. The "dot" is a galaxy forming a hexagon.
5. A "black hole" or vortex at the center of the "dot".

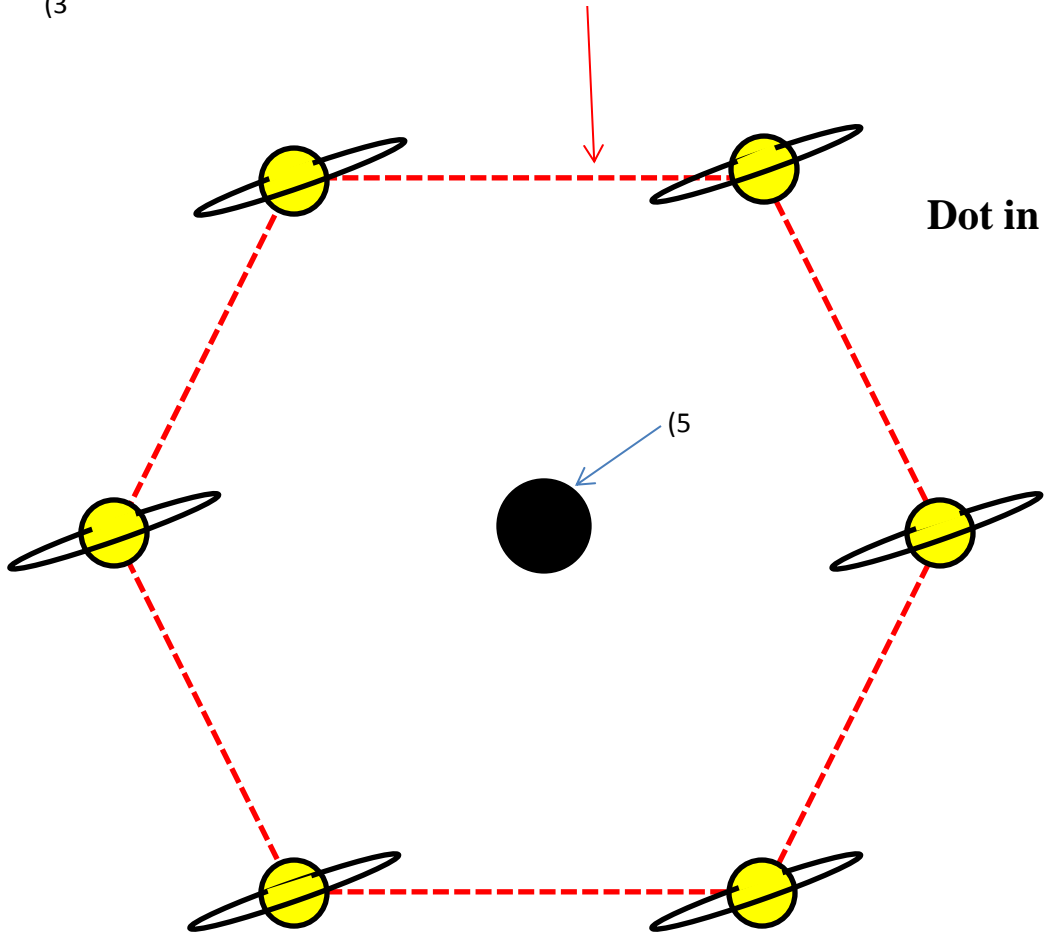

Galaxy in Dot

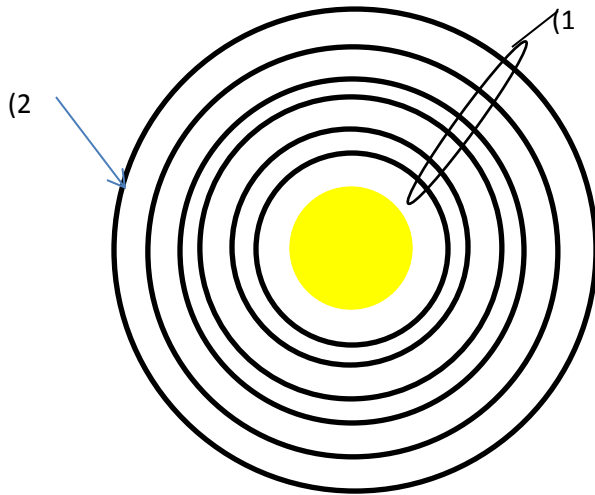

1. 6 concentric rings – similar to “Sombrero” galaxy. “6” is foundation number of this universe. It has reached the peak of its evolution. It manifests this number & multiples of 6 wherever the foundations of creation occur.
2. Rings are composed of stars. The stars are connected in strands like pictures of molecules. Some formations are complex, some are simple hexagons & pentagons.

Truths

1. Each universe is founded on a number.
2. When all possibilities have been materialized around this number & intelligence within the number brings the elements in that universe into maximum order, a higher universe is created.
3. Before the beginning of the current universe, all possibilities in this universe were exhausted & the form perfected.
4. This universe of 6 is much more organized & structured than our own universe.
5. Our universe will organize around the number 7.
6. The possibilities around the number 7 will be much greater than it was with the number 6 and the time involved will be much greater with our universe.
7. The number 7 manifest already in color, sound, & the rays of influence. This is just the beginning.
8. The Greater Universe has a long way to go, and at its end will produce a beauty beyond present imagination.
9. The “Ancient of Days” is considered the greatest of all on Planet Earth.
10. 6 is the number of this universe. It reached the peak of its evolution and it manifest the number 6 and multiples of 6 wherever the foundations of creation occur.
11. As our greater universe moves toward perfection, we will see more manifestations of the number 7.

Planetary Systems in Rings

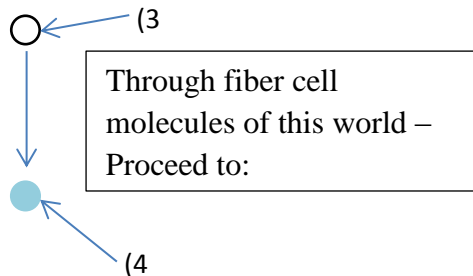
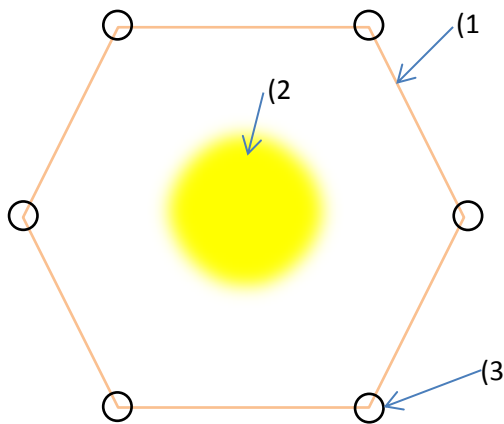

Truth Learned

1. Time is caused by a conscious registration of motion.
2. Time is altered by either changing our consciousness so motion is registered in different increments –
Or-
3. By altering the motion of all things before the consciousness.

1. Rings are composed of stars. The stars are connected in strands like pictures of molecules. Some formations are complex, some simple hexagons and pentagons.
2. The suns are bright & do not emanate a scorching heat.
3. The planets appeared circular, but clear as crystal. (The sea of glass description from the book of revelation)
 - A. Surface is perfectly smooth
 - B. In a gelatin like substance, billions of lives joined together in molecular & cellular formations.
 - C. Eons ago these lives had physical bodies, but of a crystalline nature.
 - D. They fulfilled their measure of their creation.
 - E. United for a great sleep & journey into greater consciousness.
 - F. They retain their individual identity, yet have united with the atom.
 - G. They are striving to join with the consciousness of the life in or greater universe.
 - H. The very atoms & even the tiny lives are attempting to share our consciousness.
 - I. We are a God to many universes within.
4. Atom of this next universe
 - A. Similar to atoms of our universe
 - B. More circular & less heart shaped
 - C. Protons & Quarks were of the upper end of universe of 6
 - D. Maximum of 6 electrons instead of 7 as in our universe.

The Universe of Five (5)

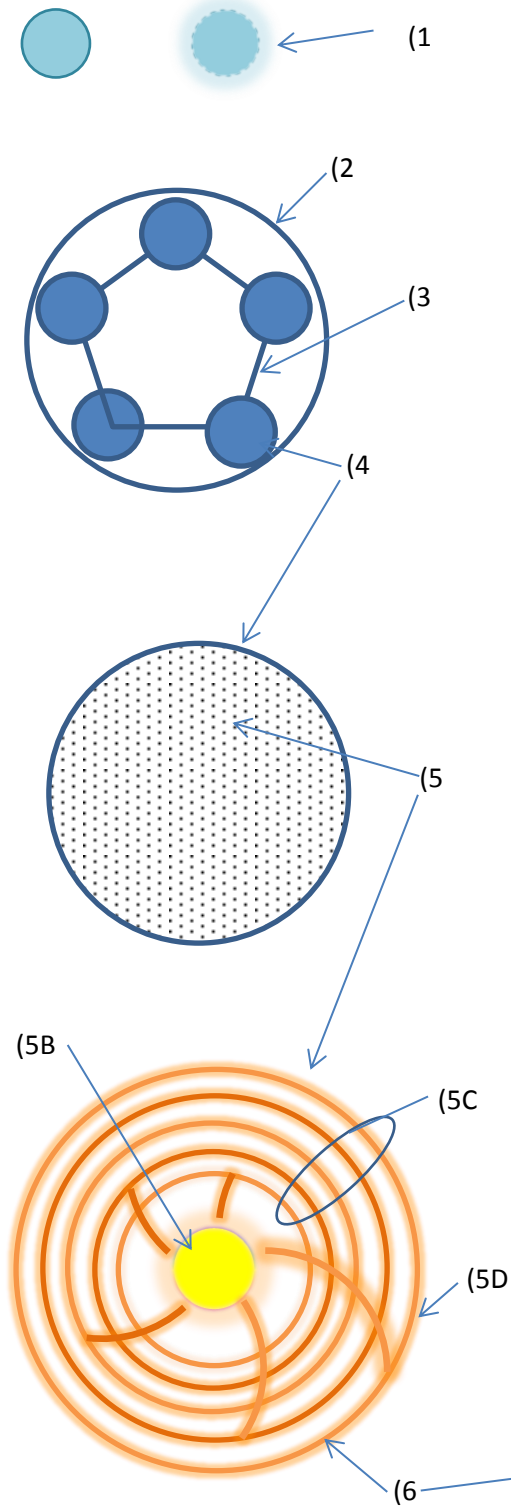

1. Electron blinks in and out of existence, but with a different sequence than our universe.
2. Nucleus
3. Particles of nucleus formed in a shape of a pentagon.
4. Within this particle are infinite number of particles.
5. Each particle is a galaxy with a highly defined structure.
 - A. At the center of the particle the object has the appearance of a ball of fire.
 - B. Five (5) arms extending to create 5 concentric rings looking a lot like a ringed body, similar to Saturn. The rings were of a fiery nature.
 - C. Rings composed of dots. The dots are stars.
 - D. One of the dots that are stars has the appearance of a sun.
6. Sun
7. 5 Major planets
8. 7 Minor planets
9. Planet surface has texture of water
 - A. Appeared angular in form
 - B. Closer it can be seen a variety of molecules
 - C. Molecules were composed of 5, 25, & 125 atoms with other combinations

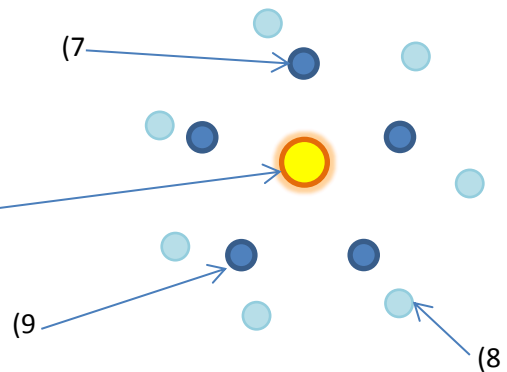

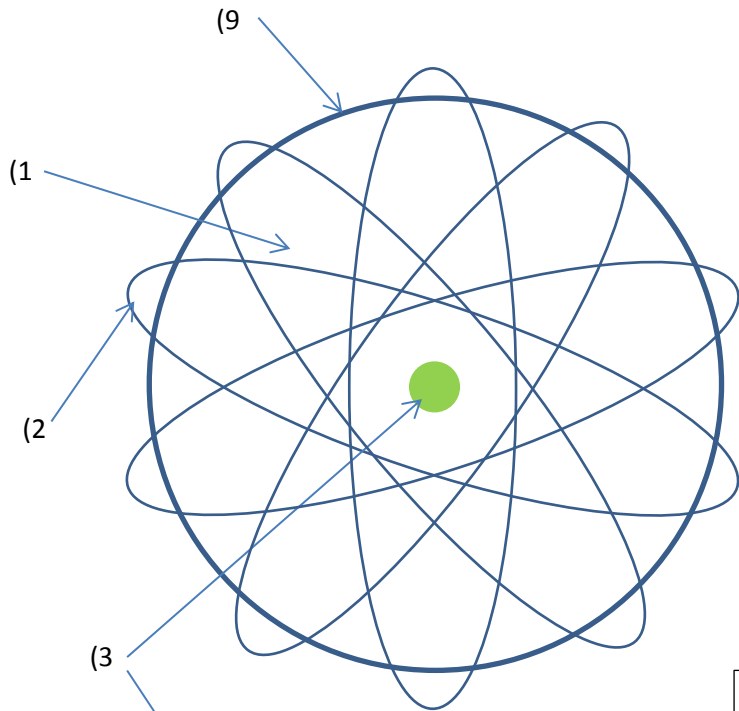

9. Planet surface has texture of water

- A. Appeared angular in form
- B. Closer it can be seen a variety of molecules
- C. Molecules were composed of 5, 25, & 125 atoms with other combinations

- 1. Atom looks like a wheel composed of 5 elliptical rings
- 2. This creates 10 protrusions on the surface
- 3. Nucleus

Truth Learned

These atoms are the foundation of the universe of 5

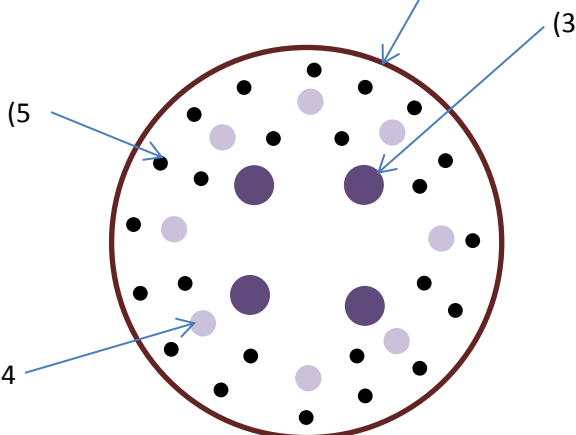
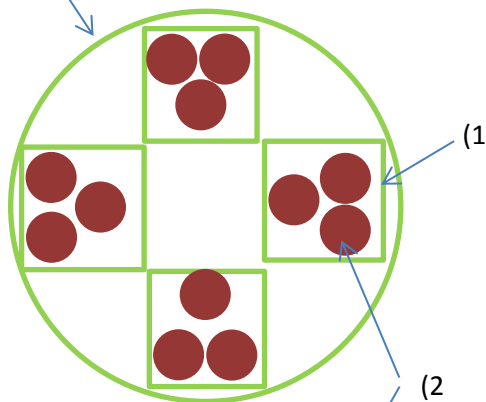

1. Four (4) particles in the shape of a square

- A. Another universe of galaxy formations.
- B. B. Particles were organized, instead of random like our universe.
- C. Organized in numerous square formations, joining in what appears to be building blocks.

2. Three (3) galaxies in formation of a triangular nature.

3. Four (4) major planets

4. Eight (8) minor planets

5. Numerous smaller bodies.

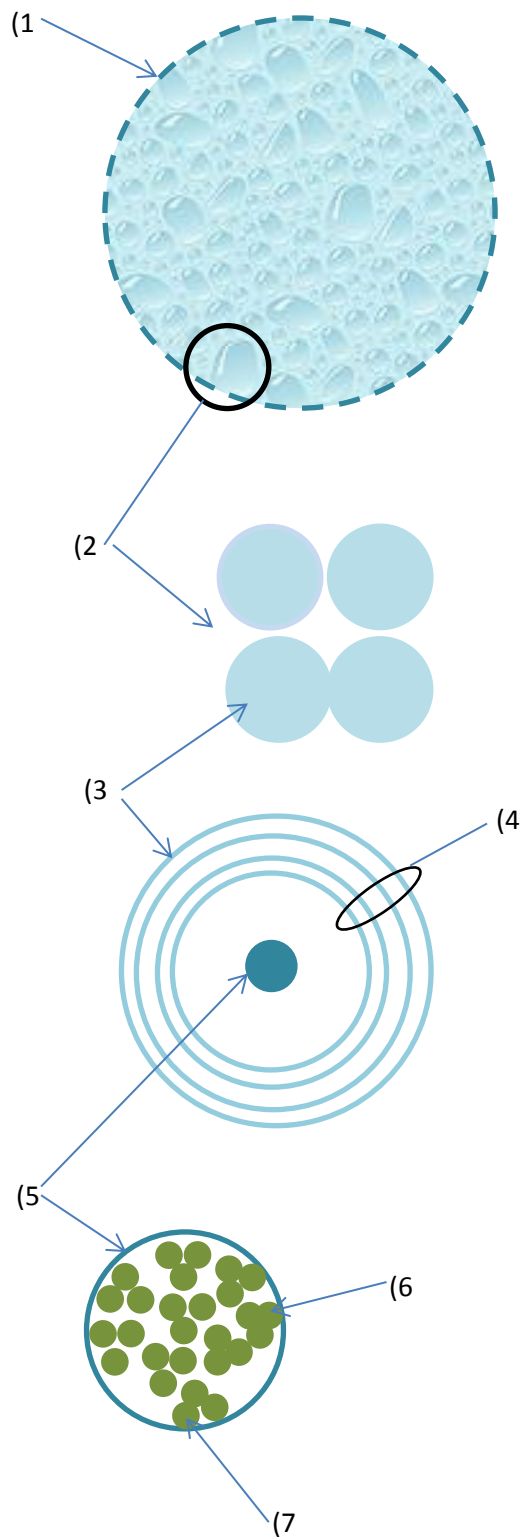

1. One of the four (4) major planets
 - A. No solid form
 - B. Composed of gaseous substance.
 - C. Had Life, but asleep as in other worlds.
2. Each life had a swirling ball of gas as body & joined together in molecular formations to create the entire body of the planet itself. (Truth: This is the pattern that we will follow in establishing a molecular formation of combinations of 7 such as the Ancient of Days has done with 6 other entities).
3. Cube of atoms
4. Four shells of electrons
5. Nucleus
6. Quark like particles organized into group of 3 triangular forms.
7. Quark like particle

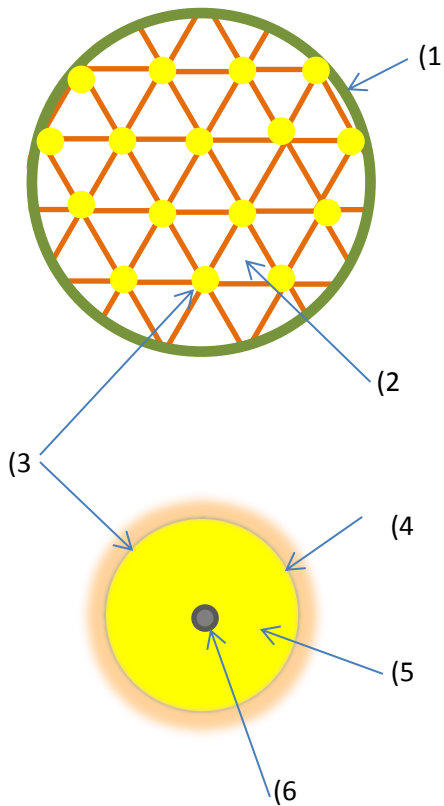

This is the foundation of all greater universes. It is built upon three items described above as delineated with the numbers 4, 5, & 6.

No. 4 shows the barrier

No. 5 shows the holy space between the barrier and the particle.

No. 6 indicates the center. It appeared white and luminous.

- A. It gave off rainbows of colors.
- B. There were elven colors. Some never seen before.
- C. The four colors never seen before are not a mixture of the primary colors. They are colors unknown to the grayer universe.

1. Quark like particle
2. Triangular formations
 - A. Seemed to create a great grid against fabric of space to give form.
 - B. Innumerable number of interlinking & interlocking triangles of glowing particles.
3. Glowing particles – Points of light
 - A. No galaxies here

Truth: All life begins with triangles. Each of the triangles is the beginning of new life.

 - B. The particle has a white shiny surface.
 - C. Emits a fiery light
 - D. Like a large bubble
4. This is the barrier to the particle
5. This space is a vast universe
 - A. The intelligence residing here is overwhelming. It is increasing rather than decreasing.
 - B. It is a great silence
 - C. There are degrees of silence as there are degrees of sound.
6. This tiny life is also a great life.
 - A. That which we normally call silence is not silence.
 - B. True sound is produced by vibration within the fabric of space.
 - C. Only when space is not disturbed will you find true silence.
 - D. In meditation deep, the Master on our world can catch a glimpse of this kind of silence.
 - E. You must pass many waves of silence to arrive at this great silence beyond silence.
 - F. This is peace that passes all understanding.

Truths Learned

1. We learn from this journey that after the universe of seven (7) is perfected, we will go on and create the universe of eight (8), then nine (9), and so on until we finish with the universe of twelve (12).
2. After the universe of twelve (12) is perfected, another great decision will be made.
3. No one knows the depth of our past or our future. There is only a beginning to beginnings. There is no one beginning.
4. This last orb, the universe of eleven (11) is the beginning and the end, the alpha and omega.
5. This last orb is the end of a great round of creation and the beginning point of all greater universes. It is the universe of all universes.
6. This universe is much greater than our own universe, but it is also a part of our current universe.
7. If we were to go smaller, we would find galaxies and worlds built upon the number eleven (11). The next universe below it would be the universe built upon the number ten (10), then the universe built upon the number nine (9) and so forth, clear down to an alpha/omega like this one.
8. The “ten” (10) universe would have 10 colors, and the “nine” (9) universe would have 9 colors and so on.
9. This alpha/omega particle contains trillions of universes. With this understanding, there are trillions of atoms that compose who we are in our universe of “seven” (7). This would mean that there are trillions times trillions of universes within us. In essence we are a God to these universes. Our great purpose is to learn how, and then share consciousness with all these universes within us.
10. Part of the goal of the Great Decision was to create the perfect circle. The universe of “eleven” (11) came very close. The perfect circle will manifest at the end of the universe of “twelve” (12). The grand universe will bring perfect understanding & recollection. We will then understand back to the first alpha/omega numbers.
11. When the universe of “eleven” (11) was finished, it was alone. There was only one of them, yet each molecule, atom & cell has untold billions of these points within them.
12. When the universe of “eleven” (11) was finished, its complexity and vastness far exceed anything that is in our current universe.
13. In the beginning, the universe of “eleven” (11) manifested as the mind of God.
14. This universe of “eleven” (11) was at one time all there was. It was formed a vast universe of universes. This mind of God within this past universe put distance between itself and the universe, creating a ripple or wavelength in space that caused a wavelength & points to manifest in the fabric of space. Each of these points was an exact duplicate of the universe of “eleven” (11), caused by an explosive expansion of the mind of God. The number of these points was so great that the number is beyond imagination. This created all there was in the greater universe through gathering together & intelligently organizing.
15. The universe of “eleven” is the mysterious singularity of scientific theory which scientist refer to as the “

16. Why was it not permitted to explore the universe of “eleven” (11).
- A. The complexities of the universe of “seven” (7) is beyond our comprehension and complexity.
 - B. The universe of “eight” (8) will be many more times beyond the universe of “seven” (7)
 - C. The universe of “eleven” (11) is so far removed it will be impossible to understand.
17. That which has been created in the past has been created again. We are a part of that original universe of “eleven” (11).
- A. With this creation there is a slight twist or improvement.
 - B. If we were to look at the past universe of “seven” (7) we would see it as perfect and duplicate it exactly, and there would be no improvement.
 - C. The basic intelligence of our universe of “seven” (7) is greater than in the past microcosm built on the number 7.
 - D. Left to build with our enhanced intelligence, we can create a more perfect universe on the higher level than currently exist on the previous universe of “seven” (7).
 - E. If we could enter the universe of “eleven” (11) and got to the universe of “seven” (7) we would find ourselves or an aspect of ourselves, which is currently asleep, since the universe is perfected.
 - i. That essence which is us is duplicated or reflected, and is now manifest as me in the greater universe. Which at this point is the universe of “seven” (7).
 - ii. There is one me, but I have multiplied myself in to many (trillions) just as God has done.
 - F. There is always more to learn no matter how high up the ladder you go.
 - G. One of the great keys is to always give thanks!

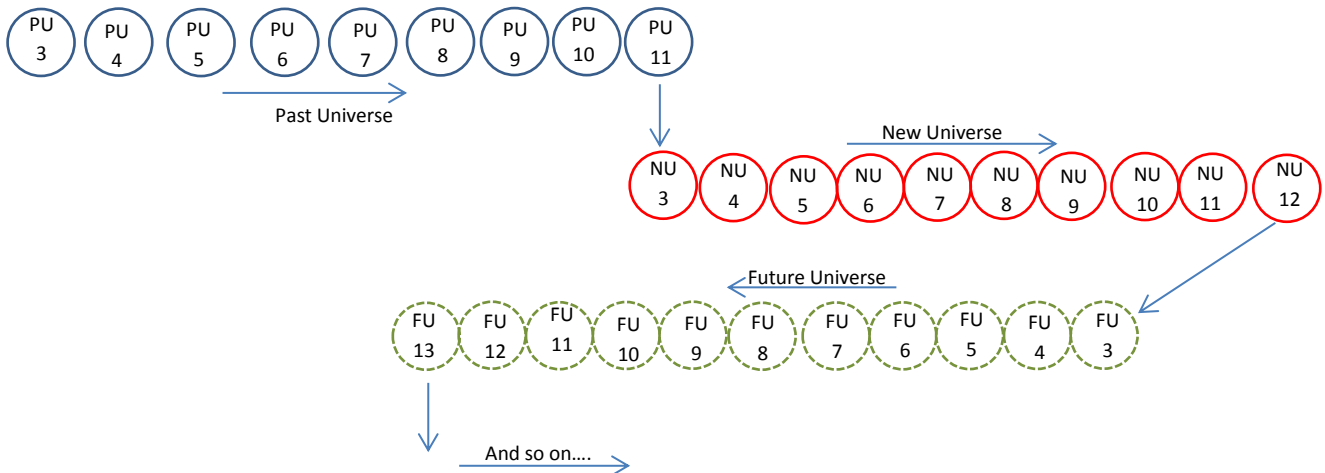

Truths Learned

1. With the past universe of “eleven” (11) as the foundation of every atom in this greater (New) universe, I am a part of every atom. This means that just as God is in everything manifest in this universe:

- A. I am a part of every created things
- B. Everything of this greater universe has innumerable reflections of me.
- C. My motive, actions, and acts towards others and created things has consequences upon myself.
- D. In my own body, there are innumerable reflections of me in the universes contained within me, as well as every other creation.
- E. I am in the Father and He is in me.
- F. Disciples and Initiates will do less filtering with the truth and take knowledge more seriously.
- G. Always give thanks!
- H. We are to bless others!
- I. This microcosmic being of the past universe “eleven” will also be the being of the new universe “eleven” (11).

